

# Data Sheet



Article number: 021816025232

Description: Clamp with bracket and rubber  
SPGU 6025. 232/30 SK

## Measures

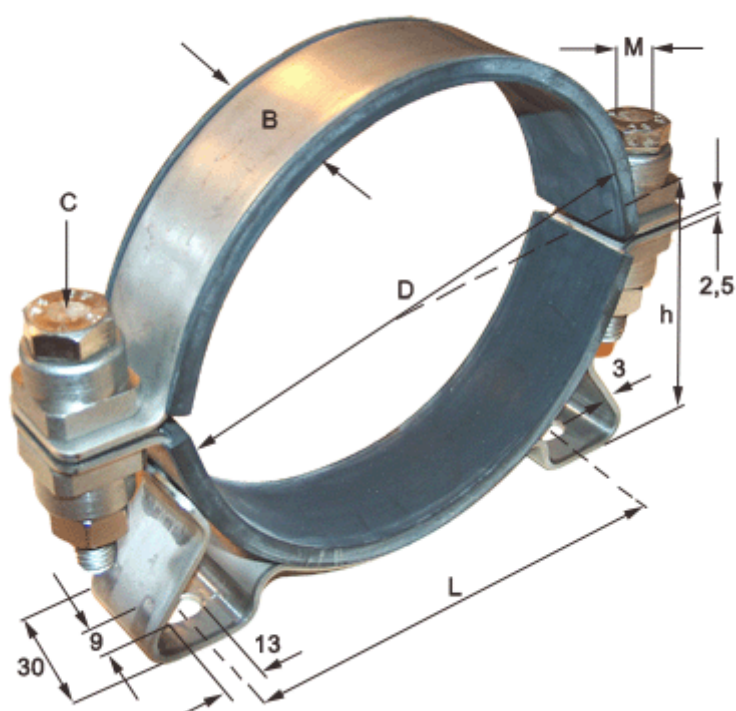

C (screw type) = SK hexagon screw

Diameter D = 232

h = 124

L = 216

Width B = 30